

Article number: 01010331
 Description: Retaining ring A 17 DIN 471
 Stainless 411
 Note: Fitted with ZGA pilers

Measures

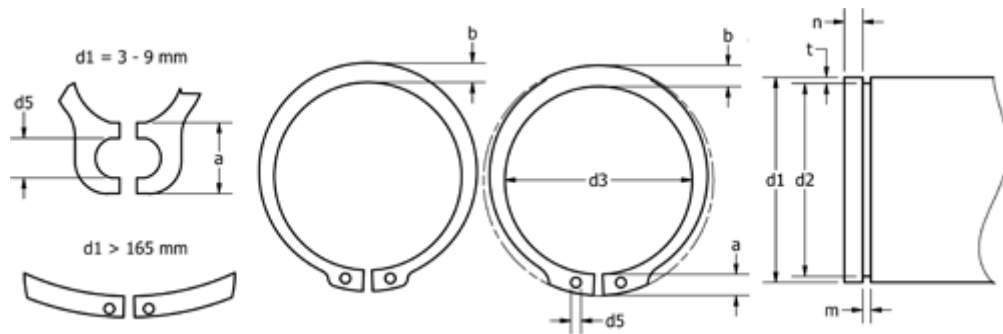

a max	= 3.8	FN kN	= 3.4	s	= 1.00
AN mm ²	= 20.8	FRg kN	= 2.40	t	= 0.40
b	= 2.3	FR kN	= 8.00	tol	= -0.11
d1	= 17	g	= 1.0	tol	= -0.06
d2	= 16.2	K kN-mm	= 21.60	tol	= +0,10-0,36
d3	= 15.7	m min	= 1.10	Tong	= ZGA-1
d5 min	= 1.7	n abl x 1000	= 41.0	Weight kg/1000	= 0.820
Description	= A17	Nominal drive	= 1.2		